

Reinhold Heuvelmann, German National Library

Moving to MARC 21 - Moving Ahead



Layers of Information

- Reality
- Communication
- Resources
- Rules
- Formats
- Shell Structures
- Coded Character Sets
- Bits and Bytes

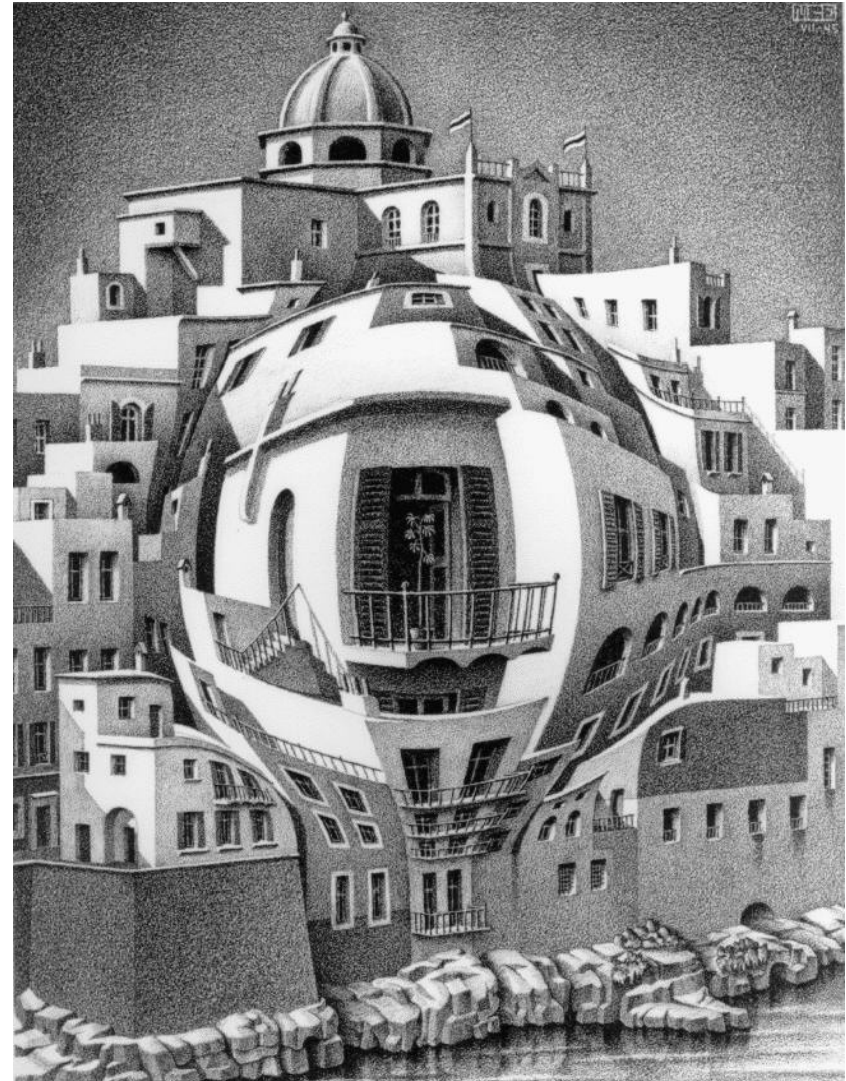

© The M.C. Escher Company B.V

Libraries in Germany (1)

- German National Library (Leipzig, Frankfurt)
 - Large State Libraries: Berlin and Munich
 - State Libraries
 - University libraries
 - Research libraries
 - Zentrale Fachbibliotheken
(Medicine, Economics, Engineering)
 - Public libraries
 - School libraries
 - Church libraries
- . . .

Libraries in Germany (2)

- "Sondersammelgebiete"
 - subject-specific
 - regional
 - material-specific

- "Sammlung Deutscher Drucke"
 - 1913 ff = Deutsche Nationalbibliothek
 - 1871 – 1912 = StB-PK Berlin
 - 1801 – 1870 = UB Frankfurt/M.
 - 1701 – 1800 = SUB Göttingen
 - 1601 – 1700 = HAB Wolfenbüttel
 - 1501 – 1600 = BSB München

Libraries in Germany (3)

German Regional Library Networks

+ Austria: OBV

+ Switzerland: IDS

+ German Union Catalogue of
Serials (ZDB)

=>

Consortium of Library Networks



German National Library

- Central archiving library and national bibliography centre
- Collecting, permanently archiving, fully documenting and bibliographically indexing all German and German-language publications from 1913 and making them accessible to the general public
- Including online publications
- National and international partnerships
- Projects
- Authority data
- Standardization

Standardization for Libraries in Germany, Austria and Switzerland

- Committee for Library Standards
- Office for Library Standards
- Expert Groups
 - Authority Data
 - Data Formats
 - Descriptive Cataloging
 - Subject Cataloging
- Offices for different subareas of standardization

Rules

- RAK (Regeln für die Alphabetische Katalogisierung)
 - RAK, RAK-WB, RAK-ÖB, RAK-NBM, RAK-Musik, RAK-Karten
 - regional Rule Interpretations
- RNA (Regeln für Nachlässe und Autographen)
- RSWK (Regeln für den Schlagwortkatalog)
- Dewey Decimal Classification
Project "DDC Deutsch"

Format: MAB

- "Maschinelles Austauschformat für Bibliotheken" (Machine-readable exchange format for libraries)
- established in 1973 ("MAB1")
- revised in 1994 ("MAB2")
- Parts: Bibliographic, Authority, Holdings, Classification, Addresses
- 1998 - 2004: process of internationalization (Unicode, Dublin Core, MAB english, FRBR, XML)

"Changing for international formats and codes (MARC21, AACR2)" (2002 - 2004)

- internationalization of library standards (cataloging rules and formats)
- vivid discussions
- feasibility study (strategic, technical, economical aspects), funded by DFG
- decisions:
introduction and uniform use of MARC 21 as the exchange format for all libraries in Germany and Austria

active cooperation in the development of new rules

Changeover to MARC 21 (2005 - 2009)

- Standard compliance
- Interoperability
- Abandon historic burdens
- Existing rules, models, data, functionalities
- Language of cataloging: German
- MARC 21 as a communications format,
not as a cataloging format
- MAB "stabilized"

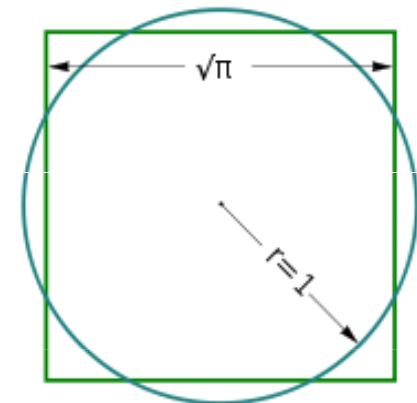

Changeover to MARC 21 (2005 - 2009)

Part 1: Preparations

- Training
- Multipart monographs
- Linking techniques
- Mapping MAB to MARC 21
- DDC
- MARBI
- Local Elements
- Translation
- Coded character sets

Decisions

- Series data in MARC Bibliographic records
- Multipart monographs in one record per volume
- No ISBD punctuation, if it is redundant to MARC 21 field or subfield coding;
if needed:
at the beginning of a subfield,
or inside a subfield
- Non-sorting control character technique

Changeover to MARC 21 (2005 - 2009)

Part 2: Production

- Re-programming all existing MAB interfaces and replacing them by their MARC 21 equivalents
- Some minor changes in data and cataloging practice
- Done / to be done in all institutions (networks, libraries)
- Vendors
- German National Library: from 2008 on, and retrospectively

The solution so far ...

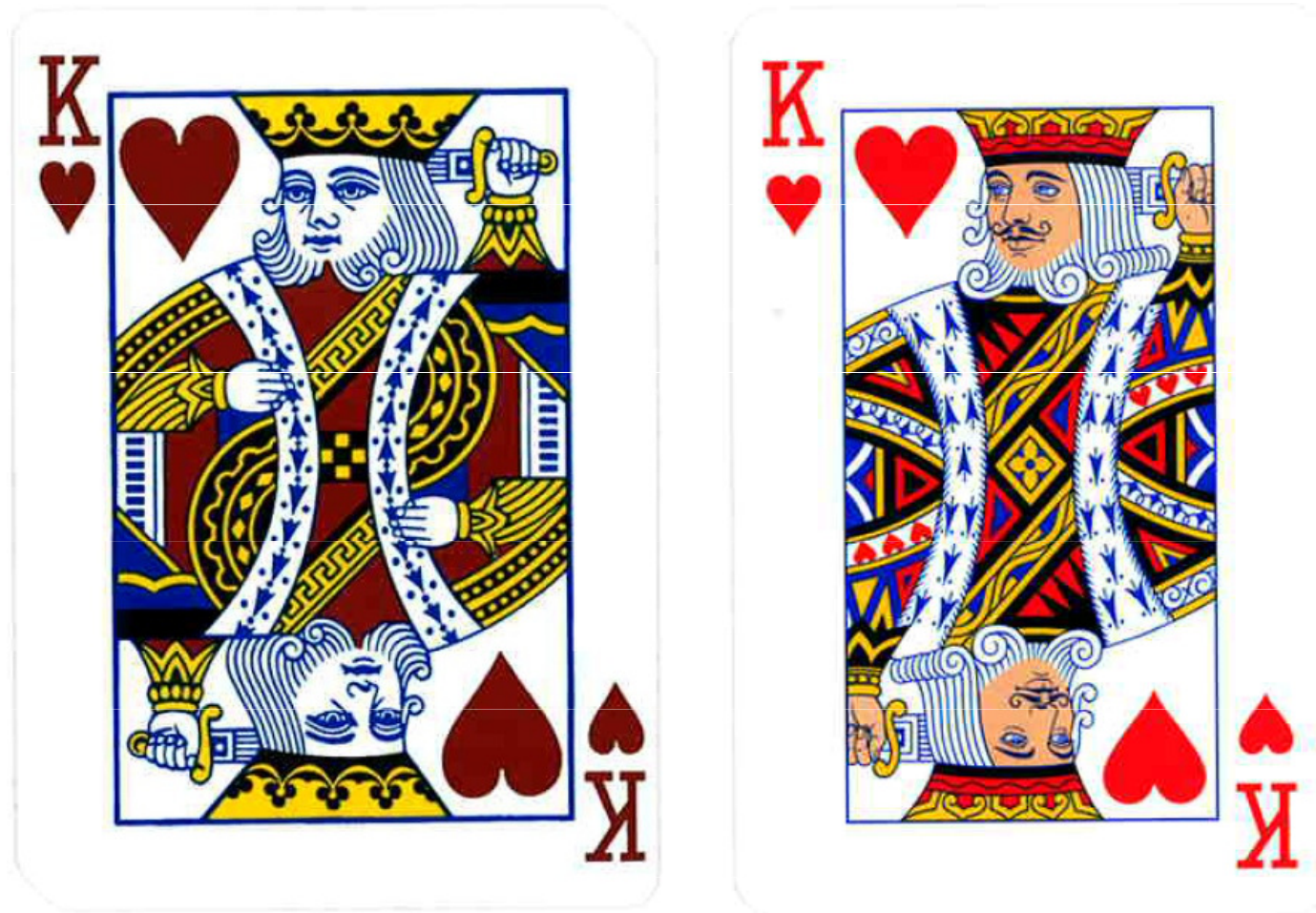

Changeover to MARC 21 (ongoing)

Part 3: Marketing

- "Errors"
- Explanations
- Discussions
- Solutions



MARC 21, and the Future



Part of the Puzzle (1): FR-Family

- FRBR
- FRAD
- FRSAD

- FRBR Review Group
- => "FRBR 2.0"

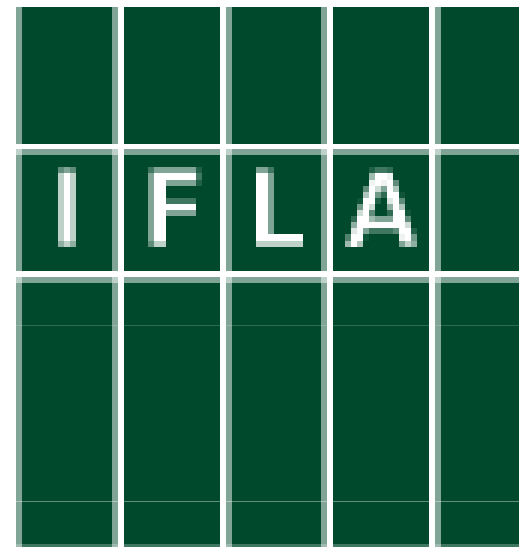

Part of the Puzzle (2): RDA

- Rules, Toolkit
- Elements, Registry
- Semantic Web: Linked Data, URIs, RDF
- Syntax ?
- RDA/MARC Working Group



Part of the Puzzle (4): MODS & MADS



- MODS/MADS Editorial Committee

Part of the Puzzle (5): De-constructing MARC

- Rules
- Cataloging system
- Elements
- Order
- Display
- Punctuation
- ISO 2709, or XML, or JSON
- MARC-8, or Unicode

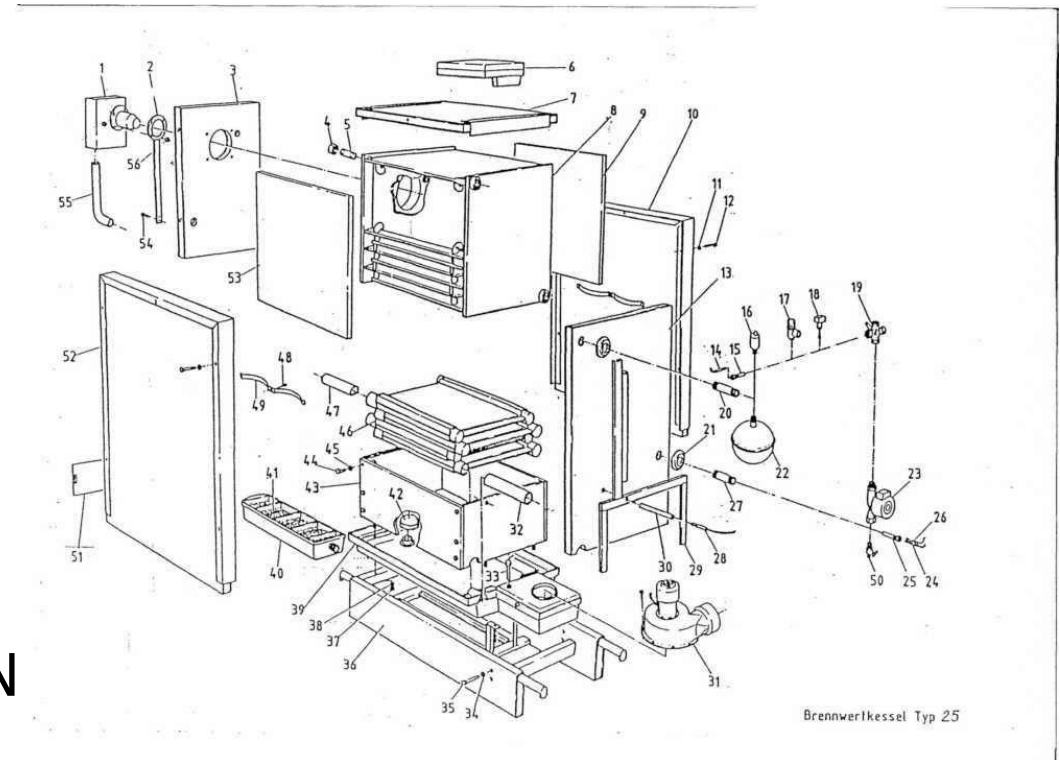

Part of the Puzzle (6): ISBD & ISBD Punctuation

- MARC Leader/18 "c"
- PCC ISBD and MARC Task Force

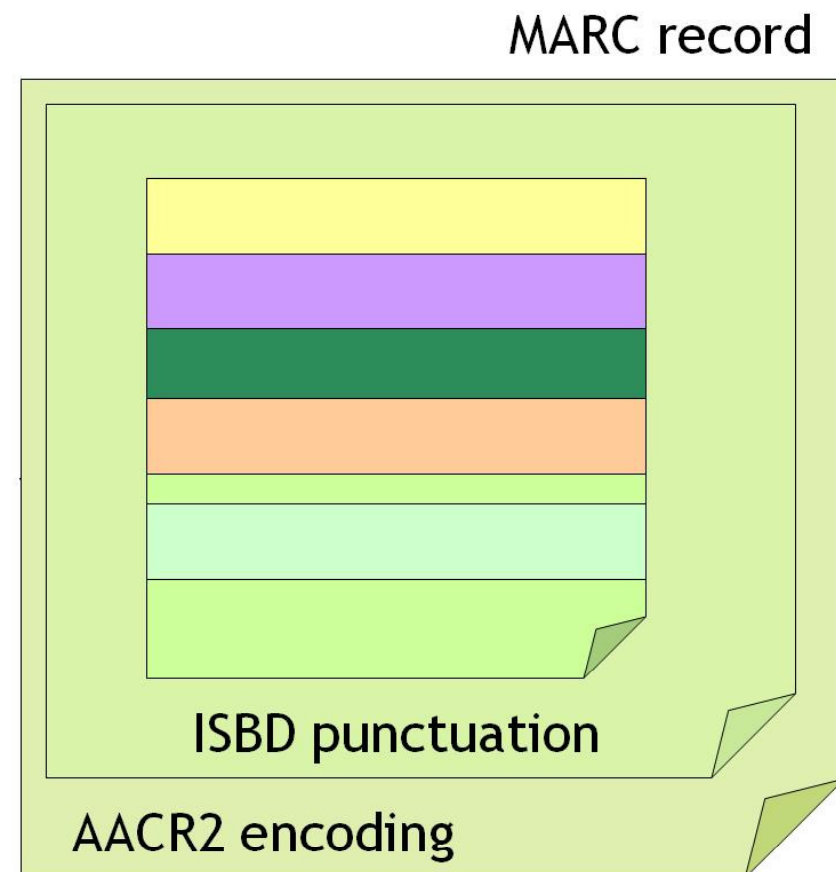

Part of the Puzzle (7): C o m m u n i c a t i o n s F o r m a t



Time to move on ...





Community & Partnerships



Library and Archives
Canada

Bibliothèque et Archives
Canada



The world's libraries.
Connected.™

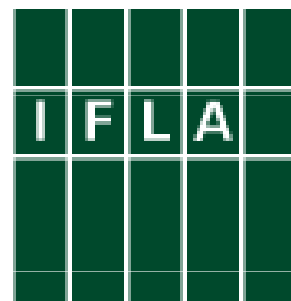

Thank you!

Questions?

r.heuvelmann@dnb.de

